

ALN - gangbaner, trapper og rekkverk.

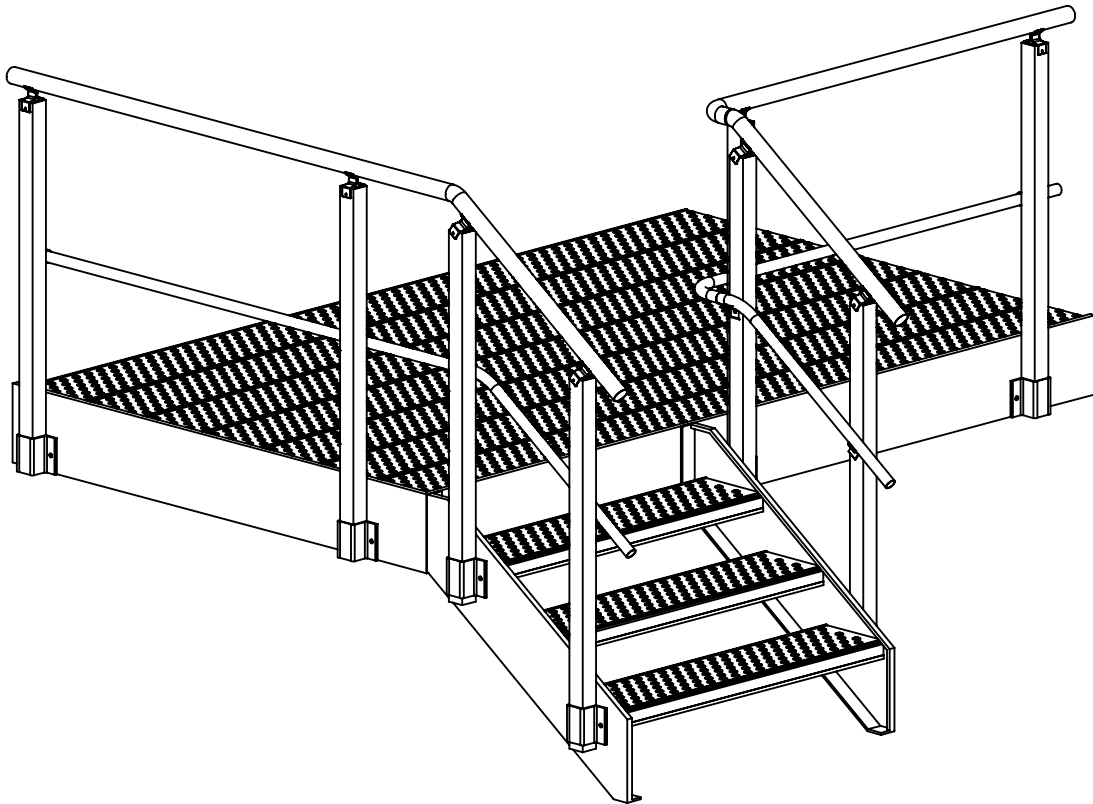

Alle løsninger leveres ferdig sammensatt eller i løse deler etter avtale.

Vanger.

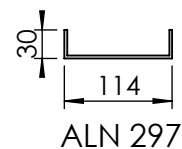
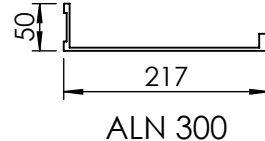
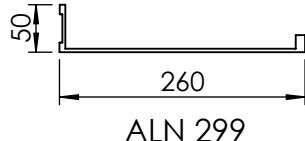
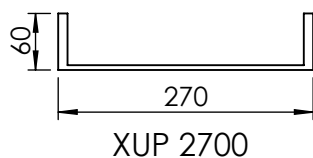

Trinn.

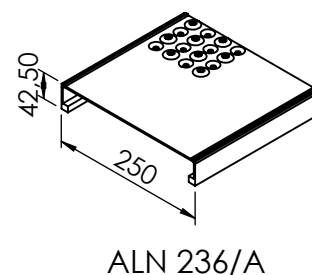
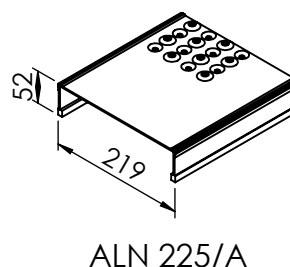
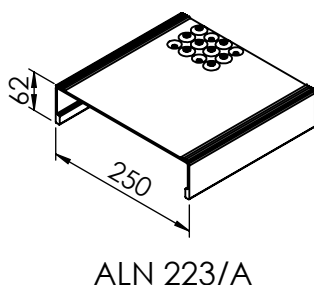
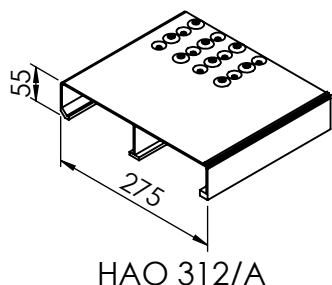

Det er mest vanlig at trinnene sveises direkte til vangerne. Men trinn kan også leveres med hullet endestykker.

Endestykkeprofil med stansede hull.

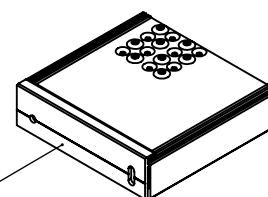

ALN 223/A

Trinn med rillemønster kan også benyttes (f.eks. ALN 240/C).

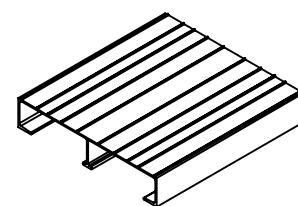

ALN 240/C

Amplirist er også anvendelig som trinn.

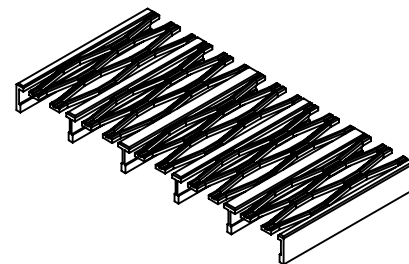

Amplirist 213,5-400

Det finnes flere typer trinnprofiler, også for skruerinnfesting. Ta kontakt med ABAS dersom du har spørsmål.

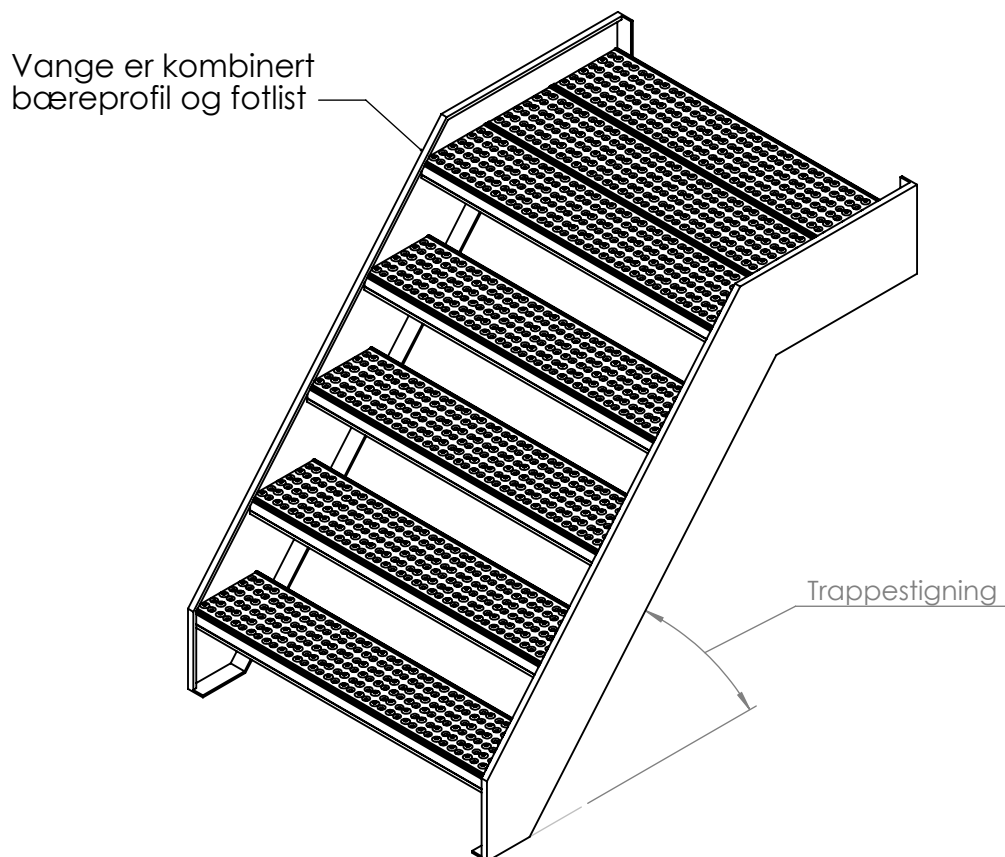

Merk maks trappestigning ved disse kombinasjonene:

Trinn	Vange ALN 300	Vange ALN 299	Vange XUP 2700
ALN 225/A	50°	ubegrenset	ubegrenset
ALN 236/A	42°	64°	70°
ALN 223/A	37°	57°	61°
HAO 312/A	33°	48°	53°

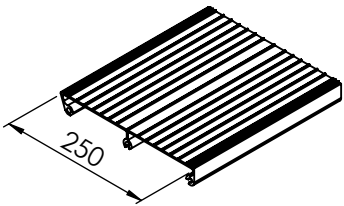

ALN 271

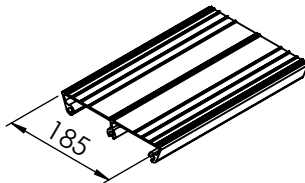

ALN 192

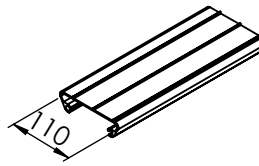

ALN 359

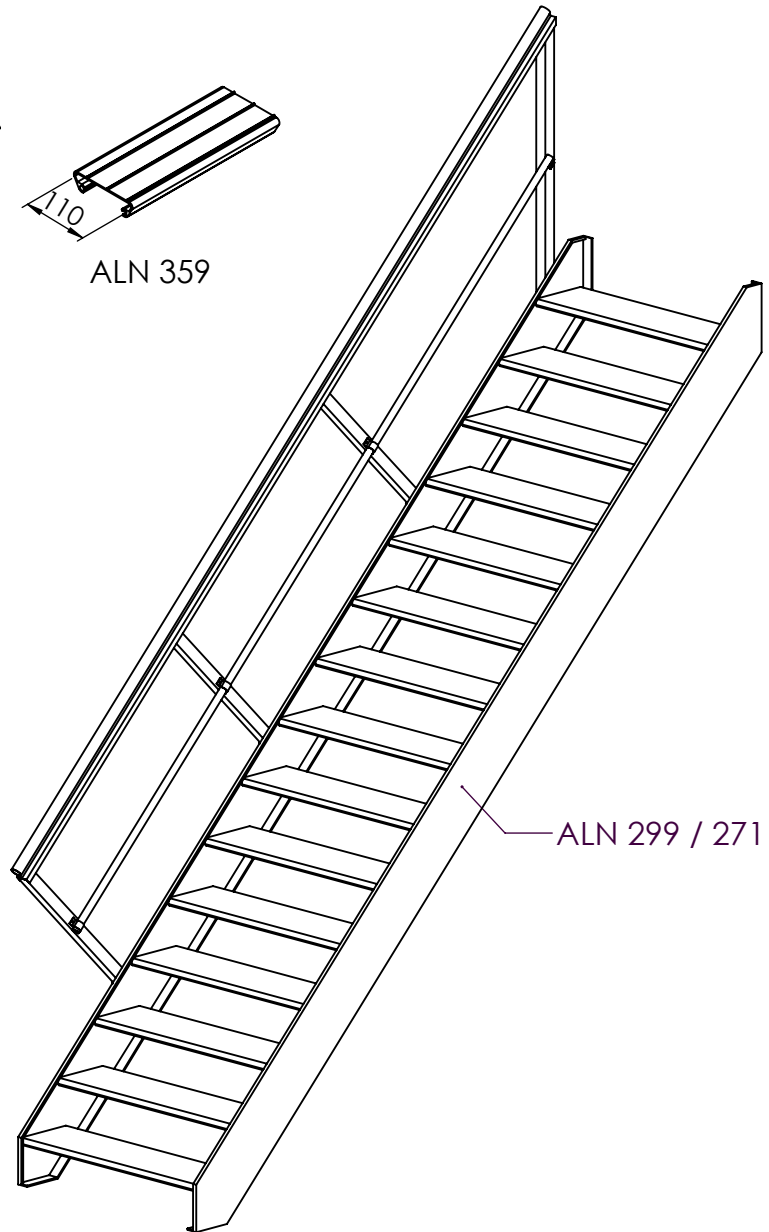

ALN 299 / 271

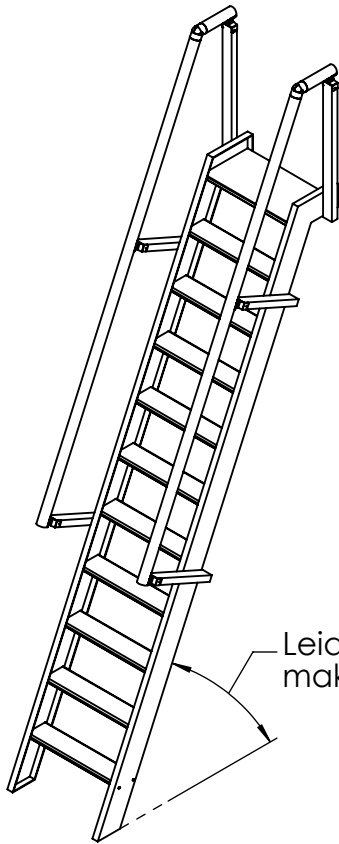

Leider ALN 359 / ALN 297 med maks stigning 77°.

Trinnene monteres med Ejot skuer eller tilsvarende, eller sveises.